

Microstrip Circulator

Part Number: KTMC-402A1

Key Features

- Frequency Range: 4.5GHz-5.0GHz
- Good Consistency
- Small Size, High Precision
- High Isolation, Low Insertion Loss
- Wide Operating Temperature Range: -55°C~+85°C
- Widely Used in Various Millimeter Wave Radar & TR Components

Electrical Specifications at Room (25°C±5°C) Temperature

Part Number	Freq. Range (GHz)	Bandwidth Max. (MHz)	Insertion Loss Max. (dB)	Isolation Min. (dB)	VSWR Max.	Forward Power (W)	Connector Type
KTMC-402A1	4.5 - 5.0	full	0.5	19	1.30	20	GWB

Mechanical Dimensions (mm)

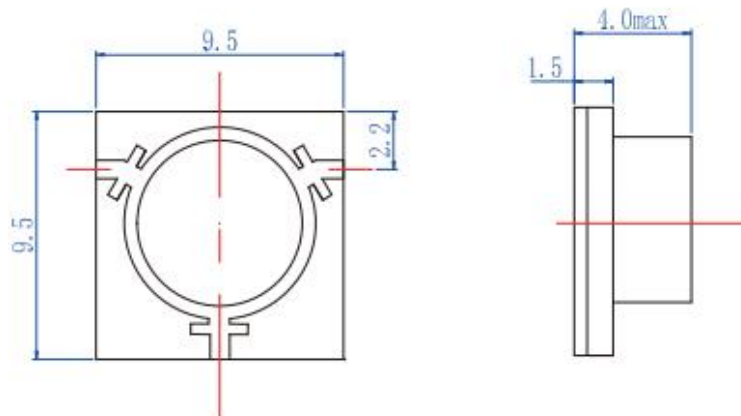

HOW TO ORDER

